

### LEFT AND RIGHT CHANNELS

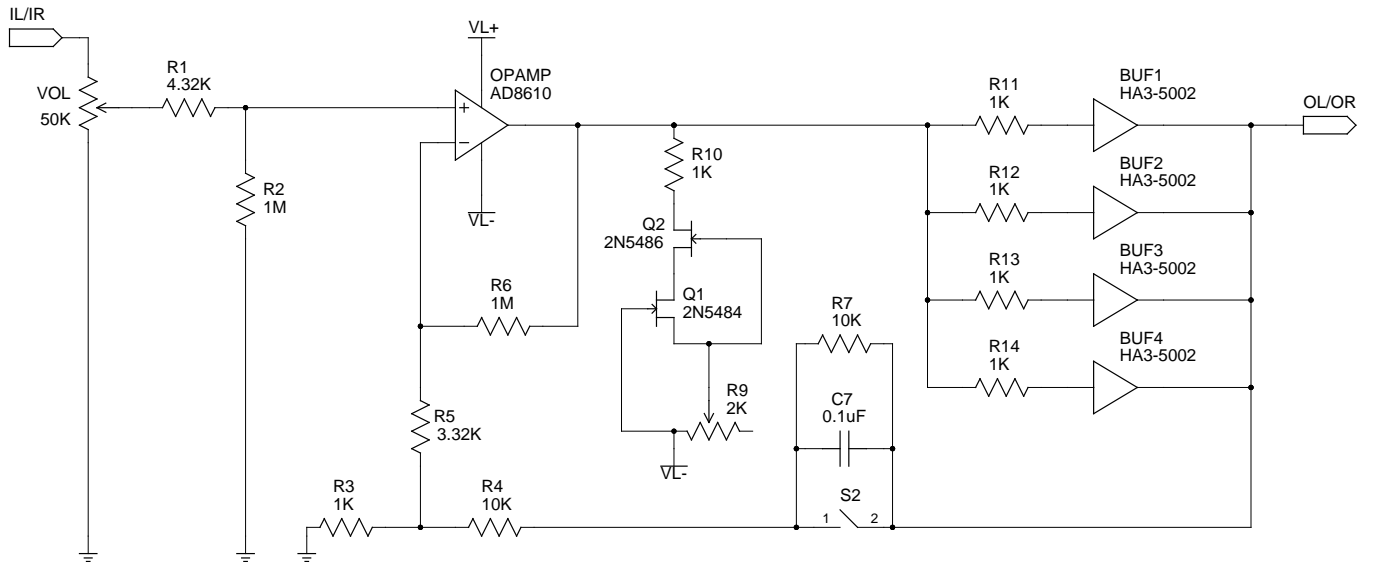

### GROUND CHANNEL

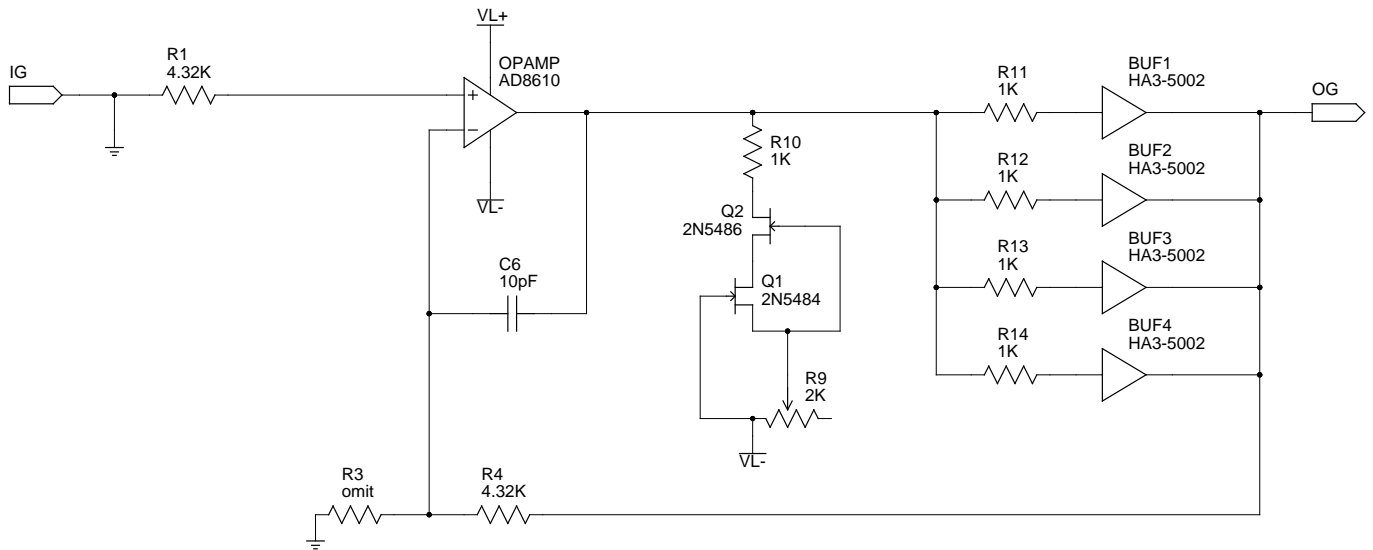

TITLE	PPA Amp Channels	<a href="http://tangentsoft.net/audio/ppa/">http://tangentsoft.net/audio/ppa/</a>
FILE:	\$Source: /usr/local/cvsroot/docs/audio/ppa/ppa-amp.gsch,v \$	
DATE	\$Date: 2004/06/30 03:28:00 \$	REVISION: \$Revision: 1.11 \$ for PCB v1.1
PAGE	1	OF 1
		DRAWN BY: \$Author: tangent \$

### HIGH-CURRENT POWER SECTION (FOR BUFFERS)

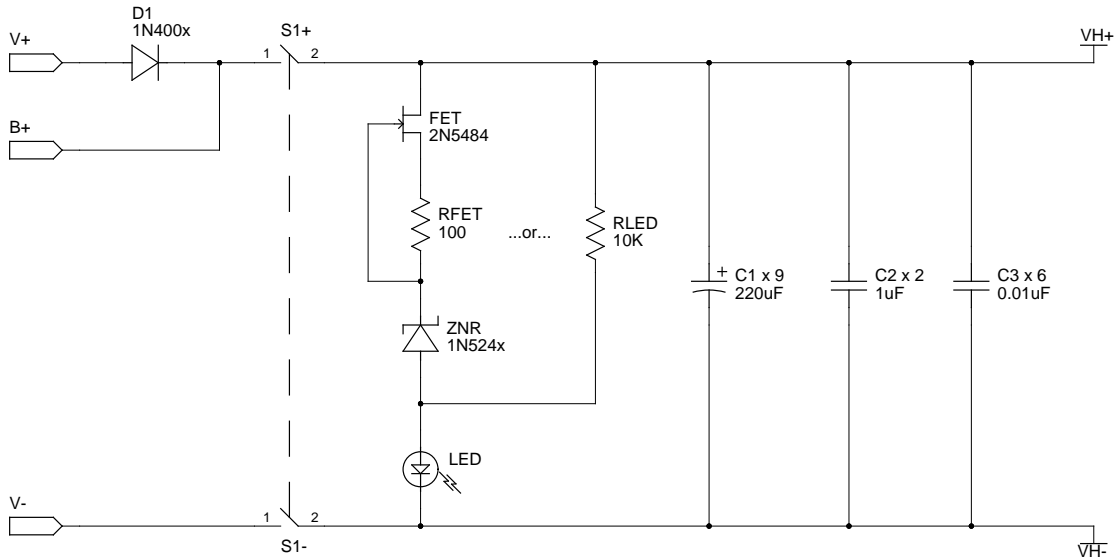

### LOW-CURRENT POWER SECTION (ONE FOR EACH OP-AMP)

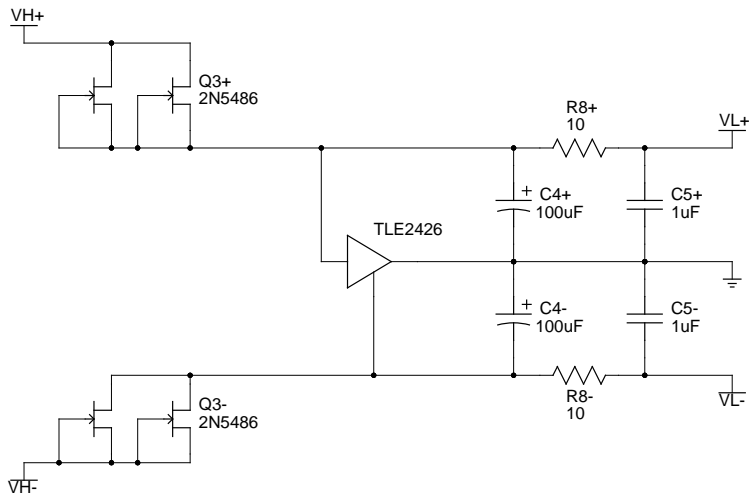

TITLE	PPA Power Supplies	<a href="http://tangentsoft.net/audio/ppa/">http://tangentsoft.net/audio/ppa/</a>
FILE:	\$Source: /usr/local/cvsroot/docs/audio/ppa/ppa-power.gsch,v \$	
DATE	\$Date: 2004/10/24 17:11:27 \$	REVISION: \$Revision: 1.8 \$ for PCB v1.1
PAGE	1 OF 1	DRAWN BY: \$Author: tangent \$